

OGL 121 G3-T3

Angled Light Barrier

- IO-Link
- 4 operating modes as IO-link parameter
- On-/off delay as IO-link parameter
- Diagnose via (by means of) IO-link
- Metal casing
- Integrated electronic module
- Sensitivity adjustable
- High operating frequency
- Light/dark switching
- Bright ring LED
- High protection class
- 5-year warranty

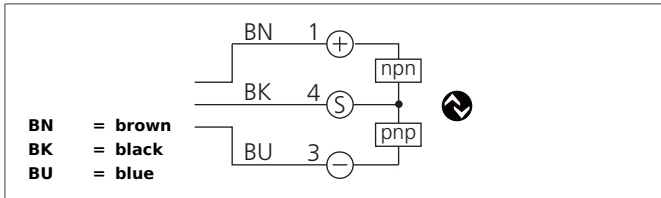

Safety instructions

The Instruments are not to be used for safety applications, in particular applications in which safety of persons depends on proper operation of the instruments. These instruments shall exclusively be used by qualified personnel.

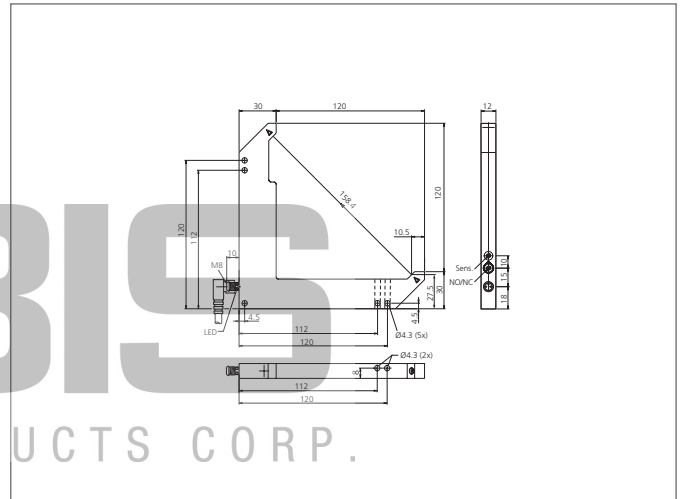

TECHNICAL INFORMATION (typ.)	+20°C, 24V DC
Operating principle	Optical
Evaluation	digital
Size	150 x 150 x 12 mm (Dimensions)
Design	Angle
Branch length inside	120/120 mm
Emitted light	Red, 660 nm, clocked
Service voltage	10 ... 30 V DC (Supply Class 2)
No-load current	< 30 mA
Operating distance	158 mm (optical axis)
Resolution	Ø 0,5 mm (min. Ø 0,4 mm)
Sensitivity adjustment	potentiometer
Switching output	Push pull, 100 mA, NO/NC, switchable
Interface	IO-Link, V1.1, COM2 (38,4kBd), Smart Sensor Profile
Voltage drop	< 1,0 V
Switching frequency	5000 Hz, (< 8000 Hz)
Reproducibility	0,03 mm
Ambient temperature, operation	-25 ... +60 °C
Ambient light immunity	20 kLx
Insulation voltage endurance	500 V
Protection class	IP 67
Protection degree	III, operation on protective low voltage
Casing material	Die-cast zinc powder-coated
Material	Mineral glass (Optik)

OGL 121 G3-T3
Angled Light Barrier



TECHNICAL INFORMATION (typ.)

+20°C, 24V DC

Connection

Connector, M8, 3-poled

Connecting cable

TK ...

